

Differential pressure gauge with microswitches With integrated working pressure indication (DELTA-comb) Model DPGS40

WIKA data sheet PV 27.20



for further approvals
see page 6

DELTA-comb

Applications

Monitoring and control of filters, compressors and pumps for:

- Boilers and pressure vessels
- Drinking and cooling-water treatment plants
- Pressure-boosting and pumping stations
- Heating technology
- Fire-extinguishing systems

Special features

- With one or two adjustable microswitches
- Shatterproof window and robust aluminium or stainless steel measuring chamber for increased requirements
- Optionally with approvals for hazardous areas
- High ingress protection, IP65, for outdoor use and processes with high condensation
- Low measuring range from 0 ... 250 mbar

Description

The differential pressure gauges of the DELTA-line product family are primarily used for the monitoring and control of low differential pressures where there are high requirements in terms of one-sided overload and static pressure.

Typical markets for these products are the process heating technology, the heating, ventilation and air-conditioning industries, the water/wastewater industry, and machine building and plant construction. For these, the main function of the measuring instruments is the monitoring and control of filters, compressors and pumps.

Wherever circuits need to be switched safely dependent on a defined differential pressure, the DELTA-switch finds its use. As the pressure passes above or below a defined set point, the switching operation is triggered.



Fig. left: With aluminium measuring chamber
Fig. right: With stainless steel measuring chamber

The switch point is accessible from the front and can be set in the range of 10 ... 100 % of the end value of the measuring range by means of an assistant scale.

The two easily readable, mechanical on-site displays need no power supply and enable the simultaneous reading of the working and the differential pressure. Furthermore, this saves on an additional measuring and sealing point, reducing additional expense for piping and mounting.

The measuring chamber, depending on the requirement and application, can be made from aluminium or stainless steel. Through the increased stability, the stainless steel measuring chamber is also suitable for gaseous media.

Functionality

The display case (1) is connected directly with the measuring chamber (2) and the process connections integrated in it.

Pressures p_1 and p_2 act on the media chambers \oplus and \ominus , which are separated by an elastic diaphragm (3).

The differential pressure ($\Delta p = p_1 - p_2$) leads to an axial deflection of the diaphragm against the measuring range springs (4).

The deflection, which is proportional to the differential pressure, is transmitted to the movement (10) in the indicator case and to the leaf springs of the microswitches (7) via a pressure-tight and low friction rocker arm (6).

Overload safety is provided by metal bolsters (5) resting against the elastic diaphragm.

With versions without Ex approval, the adjustment of the switch point is made by the adjustment screws accessible from the front (8). The assistant scales (9) simplify the setting of the switch point.

For versions with Ex approval, the switch point setting is made at the factory and cannot be carried out subsequently.

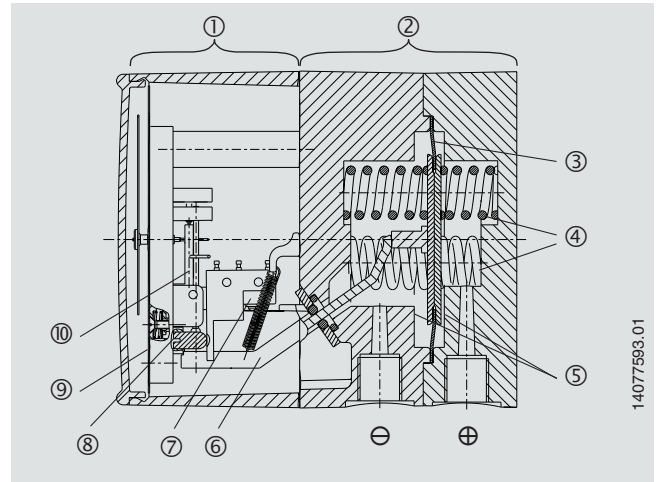

Overview of versions

Measuring chamber material		Working pressure indication		Ex approval
Aluminium	Stainless steel	Without	Ø 22 mm	
x		x		Option
x			x	Option
	x	x		Option

→ For information on approvals, see page 6

Specifications

Basic information	
Nominal size	
Differential pressure display	Ø 100 mm
Working pressure indication	<input type="checkbox"/> Without <input type="checkbox"/> Ø 22 mm
Window	
Non-Ex version	Plastic, with plug screw for switch point setting
Ex version	Plastic (switch point setting can only be carried out at the factory)
Case version	
Display case, aluminium, EN AC-Al Si9Cu3(Fe); black painted	
→ Measuring chamber, see table "Measuring element"	

Measuring element	
Type of measuring element	
Differential pressure display	Measuring chamber with diaphragm and media chambers \oplus and \ominus
Working pressure indication	<ul style="list-style-type: none"> ■ Without ■ Bourdon tube
Material	
Measuring chamber	<ul style="list-style-type: none"> ■ Aluminium, EN AC-Al Si9Cu3(Fe), black painted ■ Stainless steel 1.4571
Diaphragm, sealings	<ul style="list-style-type: none"> ■ FPM/FKM ■ NBR
Bourdon tube (working pressure indication)	Copper alloy

Accuracy specifications	
Accuracy class	
Differential pressure display	<ul style="list-style-type: none"> ■ 2.5 ■ 1.6 (only selectable for scale ranges from 0 ... 1 bar to 0 ... 10 bar)
Working pressure indication	4
Repeatability	≤ 1.6 % of measuring span
Temperature error	On deviation from the reference conditions at the measuring system: Max. ±0.8 %/10 K of end value of measuring range
Reference conditions	
Ambient temperature	+20 °C [+68 °F]

Differential pressure measuring ranges

Measuring range	
mbar	psi
0 ... 250	0 ... 15
0 ... 400	0 ... 25
0 ... 600	0 ... 40
0 ... 1,000	0 ... 60
bar	kg/cm²
0 ... 0.25	0 ... 0.25
0 ... 0.4	0 ... 0.4
0 ... 0.6	0 ... 0.6
0 ... 1	0 ... 1
0 ... 1.6	0 ... 1.6
0 ... 2.5	0 ... 2.5
0 ... 4	0 ... 4
0 ... 6	0 ... 6
0 ... 10	0 ... 10

Measuring range	
kPa	MPa
-12.5 ... +12.5	0 ... 0.025
0 ... 25	0 ... 0.04
0 ... 40	0 ... 0.06
0 ... 60	0 ... 0.1
0 ... 100	0 ... 0.16
0 ... 160	0 ... 0.25
0 ... 250	0 ... 0.4
0 ... 400	0 ... 0.6
0 ... 600	0 ... 1
0 ... 1,000	

Scale ranges for working pressure

Scale range
bar
0 ... 10
0 ... 16
0 ... 25

Further details on: Measuring ranges	
Type of pressure	Differential pressure
Special measuring ranges	Other measuring ranges on request
Unit	<ul style="list-style-type: none"> ■ bar ■ psi ■ mbar ■ kg/cm² ■ MPa ■ kPa

Process connections	
Standard	<ul style="list-style-type: none"> ■ EN 837 ■ DIN EN ISO 8434-1
Size	
EN 837	<ul style="list-style-type: none"> ■ 2 x G ¼, female thread, centre distance 26 mm ■ 2 x G ¼ B, male thread, centre distance 26 mm
DIN EN ISO 8434-1	<ul style="list-style-type: none"> ■ 2 x bite-type fitting for pipe Ø 6 mm ■ 2 x bite-type fitting for pipe Ø 8 mm ■ 2 x bite-type fitting for pipe Ø 10 mm
Materials (wetted)	
Measuring chamber	<ul style="list-style-type: none"> ■ Aluminium, Al Si9Cu3(Fe), black painted ■ Stainless steel 1.4571
Process connection	<ul style="list-style-type: none"> ■ Identical to measuring chamber (only 2 x G ¼ female thread) ■ Copper alloy ■ Stainless steel ■ Steel (only bite-type fittings)
Diaphragm, sealings	<ul style="list-style-type: none"> ■ FPM/FKM ■ NBR

Output signal	
Connection method	Microswitch
Number of switches	<ul style="list-style-type: none"> ■ Single contact, contact model 850.3 ■ Double contact, contact model 850.3.3
Switching function	Change-over contact
Switch point setting	From the outside at assistant scale by means of adjustment screw(s)
Non-Ex version	<ul style="list-style-type: none"> ■ From the outside at assistant scale by means of adjustment screw(s)
Ex version	<ul style="list-style-type: none"> ■ Factory set (subsequent switch point setting cannot be carried out)
Setting range	From 10 % to 100 % of measuring range
Switch hysteresis	<ul style="list-style-type: none"> ■ Max. 2.5 % of end value of measuring range ■ Max. 5 % of end value of measuring range

Electrical connections	
Connection type	<ul style="list-style-type: none"> ■ Cable gland M20 x 1.5 with 1 m cable, flying leads ■ Cable socket ■ Angular connector
Pin assignment	→ See drawings from page 8









Operating conditions	
Medium temperature	-10 ... +90 °C [14 ... 194 °F]
Ambient temperature	
Non-Ex version	-10 ... +70 °C [14 ... 150 °F]
Ex version	-10 ... +60 °C [14 ... 140 °F]
Storage temperature	-20 ... +60 °C [-4 ... +140 °F]
Pressure limitation	
Steady	End value of measuring range
Fluctuating	0.9 x end value of measuring range
Overload safety	Max. 25 bar On one, both and alternatingly on the ⊕ and ⊖ sides
Ingress protection per IEC/EN 60529	IP65

Approvals

Approvals included in the scope of delivery

Logo	Description	Country
	EU declaration of conformity	European Union
	Pressure equipment directive	
	Low voltage directive	
	RoHS directive	
-	CRN Safety (e.g. electr. safety, overpressure, ...)	Canada

Optional approvals

Logo	Description	Country
	EU declaration of conformity	European Union
	ATEX directive	
	Hazardous areas	
	Gas II 2G Ex ia IIC T4/T5/T6 Gb Dust II 2D Ex ia IIIB T135°C Db	
	IECEX	International
	Hazardous areas	
	Gas Ex ia IIC T4/T5/T6 Gb Dust Ex ia IIIB T135°C Db	
	EAC Hazardous areas	Eurasian Economic Community
	UkrSEPRO Metrology, measurement technology	Ukraine
	Ex Ukraine Hazardous areas	Ukraine
	Uzstandard Metrology, measurement technology	Uzbekistan
	GOST Metrology, measurement technology	Russia
	KazInMetr Metrology, measurement technology	Kazakhstan
-	MTSCHS Permission for commissioning	Kazakhstan
	BelGIM Metrology, measurement technology	Belarus

Certificates (option)

Certificates	
Certificates	<ul style="list-style-type: none"> ■ 2.2 test report per EN 10204 (e.g. state-of-the-art manufacturing, indication accuracy) ■ 3.1 inspection certificate per EN 10204 (e.g. indication accuracy)
Recommended recalibration interval	1 year (dependent on conditions of use)

→ Approvals and certificates, see website

Safety-relevant characteristic values (explosion-protected version)

Safety-related characteristic values (Ex)	
Terminals	
Switch A	„1“ / „4“ / „2“
Switch B	„3“ / „6“ / „5“
Maximum voltage U_i	DC 30 V
Maximum current I_i	100 mA
Maximum power P_i (gas)	1 W
Maximum power P_i (dust)	
$T_a \leq +40 \text{ °C}$	$\leq 750 \text{ mW}$
$T_a \leq +60 \text{ °C}$	$\leq 650 \text{ mW}$
Effective internal capacitance C_i	Negligible
Effective internal inductance L_i	Negligible

Instruments with two microswitches

If more than one circuit is connected, all conditions for the separation of two intrinsically safe circuits must be observed.

With cable socket or angular connector

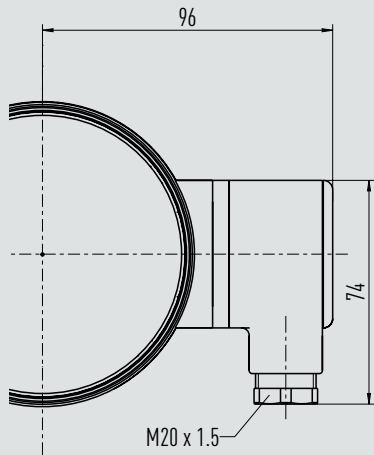



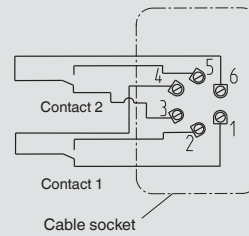

Electrical connection diagram



14078225.01

Accessories

Model	Description	Order number	
	-	Panel mounting flange, aluminium	14074004
	-	Panel mounting flange, stainless steel	14075088
	910.17	Sealings → see data sheet AC 09.08	-
	910.15	Syphons → see data sheet AC 09.06	-
	IV3x	4-way valve block, stainless steel → For dimensions see page 10	2043559
		4-way valve block, brass → For dimensions see page 10	2043567
	-	Bite-type fittings for pipe diameters 6, 8 and 10 mm	On request

Dimensions in mm

4-way valve block

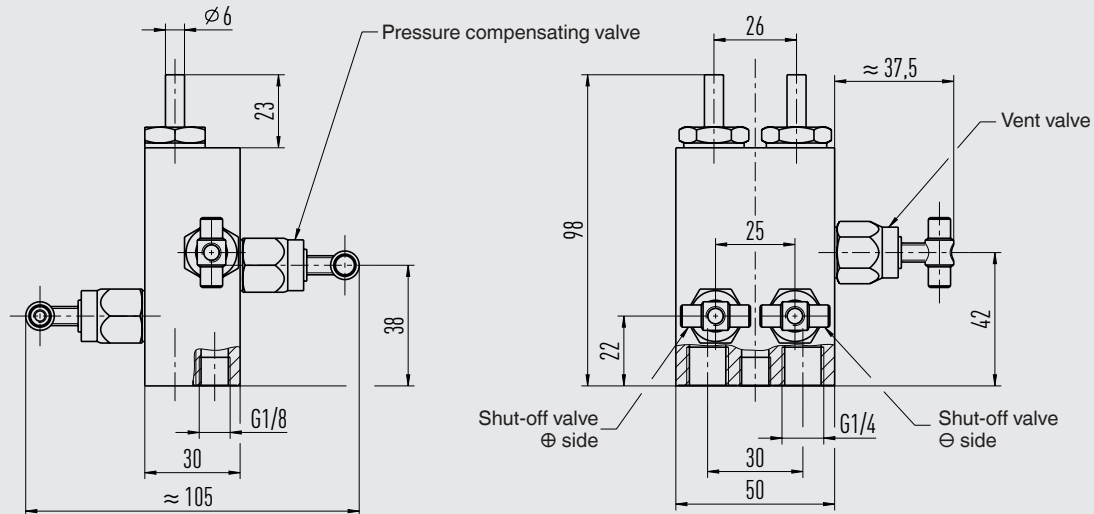

2261821.01

Ordering information

Model / Scale range / Process connection / Material of diaphragm, sealings / Number of switches / Options

© 11/2007 WIKA Alexander Wiegand SE & Co. KG, all rights reserved.
The specifications given in this document represent the state of engineering at the time of publishing.
We reserve the right to make modifications to the specifications and materials.

